

# TJ-1/500A

## 型接触器用真空灭弧室

Vacuum Interrupter For Contactor

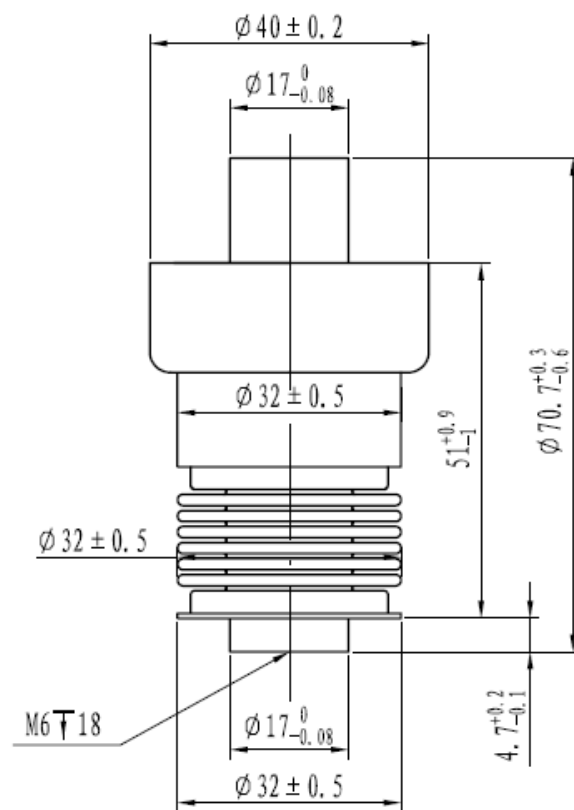



### TJ-1/500A 真空开关管技术参数

序号 No.	主要技术参数 Main Technical Specification	型号 Type	
		TJ-1/500A	
电气参数 ELECTRIC RATINGS			
1	额定电压 Rated Voltage	kV	1
2	额定电流 Rated Current	A	500
3	额定频率 Rated Frequency	Hz	50/60
4	额定短时（1分钟）工频耐受电压 Rated Short-time(1min) Power-Frequency Withstand Voltage	kV	6
5	触头自闭力下的回路电阻 Circuit Resistance At Contact Force From Atmosphere	$\mu \Omega$	$\leq 80$
6	雷电冲击耐受电压 Lightning Impulse Withstand Voltage	kV	/
7	额定关合能力 Rated Making Capacity	kA	6.25
8	额定开断能力 Rated Breaking Capacity	kA	5
9	极限开断能力 Limited Breaking Capacity	kA/3Times	/
10	额定短时耐受电流，20秒 Rated Short-time Withstand Current, 20s	kA	4.21
11	额定峰值耐受电流 Rated Peak Withstand Current	kA	10.525
寿命 LIFE			
1	机械寿命 Mechanical Life	Times	5,000,000
2	电寿命 Electrical Life	Times	2,600,000
3	储存时间 Storage Life	years	$\geq 20$
4	触头允许磨损厚度 Contacts Erosion Limit	mm	2
机械数据 MECHANICAL DATA			
1	触头自闭力 Contact Force From Atmosphere	N	44~57
2	触头反力 Counterforce of Contacts at Full Stroke	N	56~69
配套的真空开关设备应满足的机械参数 MECHANICAL DATA OF VACUUM SWITH EQUIPPED WITH THE INTERRUPTERS			
1	触头开距 Contact Stroke	mm	$1.5 \pm 0.2$
2	超行程 Overtrave	mm	$1 \pm 0.2$
3	平均分闸速度 Average Opening Speed	m/ s	0.3~0.5
4	平均合闸速度 Average closing speed	m/ s	0.05~0.15
5	触头合闸弹跳时间 Contact Bouncing Duration at Cosing Operation	ms	$\leq 3$
6	额定触头压力 Rated Added External Contactfinal Force	N	20